

Description

The 15KPA Series is designed specifically to protect sensitive electronic equipment from voltage transients induced by lightning and other transient voltage events.

Features

- Fast response time
- Matte tin lead-free Plated
- Low incremental surge resistance
- Halogen free and RoHS compliant
- Typical I_R less than 2 μ A above 30V
- Compatible with industrial standard package P600
- For surface mounted applications to optimize board space
- 15000W peak pulse power capability with at 10/1000 μ s waveform, repetition rate (duty cycle): 0.01%
- High temperature soldering guaranteed:260°C/ 10 seconds

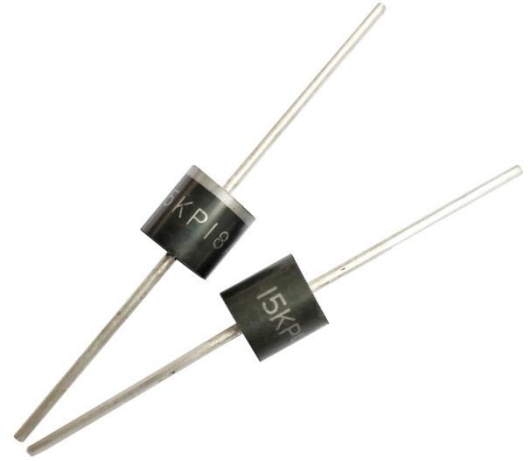

Electrical symbol

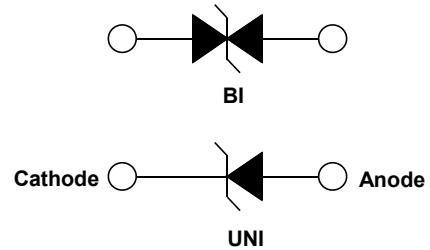

Part Number Code

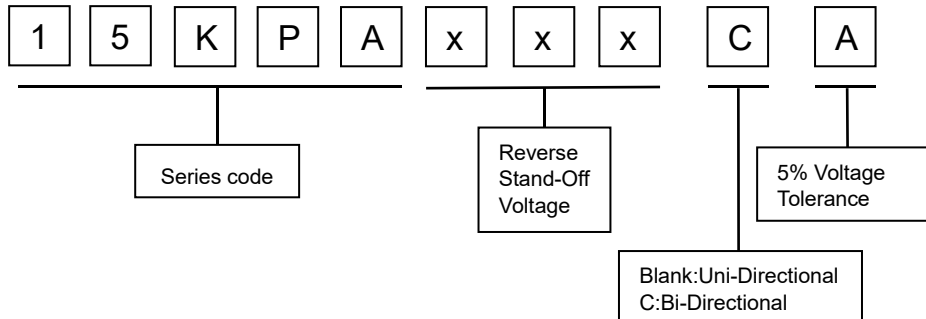

Mechanical Characteristics

Rating	Symbol	Value	Units
Peak Pulse Power Dissipation by 10x1000 μ s test Waveform (Note1)(Fig. 2)	P_{PP}	15000	W
Steady State Power Dissipation on infinite heat sink at $T_L=75^\circ\text{C}$ (Fig. 6)	P_D	8	W
Peak Forward Surge Current, 8.3ms Single Half Sine Wave Unidirectional only (Note 2)	I_{FSM}	500	A
Maximum instantaneous forward voltage at 25A for unidirectional only	V_F	3.5/5.0	V
Operating junction and Storage Temperature Range.	T_J, T_{STG}	-55 to 150	$^\circ\text{C}$

Notes:

1. Non-repetitive current pulse , per Fig. 4 and derated above $T_A = 25^\circ\text{C}$ per Fig. 3.
2. Measured on 8.3ms single half sine wave or equivalent square wave, duty cycle=4 per minute maximum.

Electrical Characteristics

Type Number		Reverse Stand-Off Voltage	Breakdown Voltage		Test Current	Max. Clamping Voltage 10/1000µs	Max. Peak Pulse Current 10/1000µs	Reverse Leakage
			V _{BR} @I _T					
			V _{RWM}	Min				
UNI	BI	V	V	V	mA	V	A	µA
15KPA17A	15KPA17CA	17.0	18.99	20.79	50	29.3	515.4	5000
15KPA18A	15KPA18CA	18.0	20.11	22.01	50	30.9	488.7	5000
15KPA20A	15KPA20CA	20.0	22.34	24.46	20	34.3	440.2	1500
15KPA22A	15KPA22CA	22.0	24.57	26.91	10	37.1	407.0	500
15KPA24A	15KPA24CA	24.0	26.81	29.35	5	40.7	371.0	150
15KPA26A	15KPA26CA	26.0	29.04	31.80	5	44.0	343.2	50
15KPA28A	15KPA28CA	28.0	31.28	34.24	5	47.5	317.9	25
15KPA30A	15KPA30CA	30.0	33.51	36.70	5	50.7	297.8	15
15KPA33A	15KPA33CA	33.0	36.90	40.40	5	54.7	276.1	2
15KPA36A	15KPA36CA	36.0	40.20	44.00	5	59.8	252.5	2
15KPA40A	15KPA40CA	40.0	44.70	48.90	5	65.8	229.5	2
15KPA43A	15KPA43CA	43.0	48.00	52.60	5	69.8	216.3	2
15KPA45A	15KPA45CA	45.0	50.30	55.00	5	72.8	207.4	2
15KPA48A	15KPA48CA	48.0	53.60	58.70	5	77.7	194.3	2
15KPA51A	15KPA51CA	51.0	57.00	62.40	5	82.9	182.1	2
15KPA54A	15KPA54CA	54.0	60.30	66.00	5	87.7	172.2	2
15KPA58A	15KPA58CA	58.0	64.80	70.90	5	93.8	161.0	2
15KPA60A	15KPA60CA	60.0	67.00	73.40	5	97.4	155.0	2
15KPA64A	15KPA64CA	64.0	71.50	78.30	5	104.2	144.9	2
15KPA70A	15KPA70CA	70.0	78.20	85.60	5	113.6	132.9	2
15KPA75A	15KPA75CA	75.0	83.80	91.70	5	122.0	123.8	2
15KPA78A	15KPA78CA	78.0	87.10	95.40	5	126.1	119.7	2
15KPA85A	15KPA85CA	85.0	94.90	104.00	5	137.6	109.7	2
15KPA90A	15KPA90CA	90.0	100.50	110.10	5	145.6	103.7	2
15KPA100A	15KPA100CA	100.0	111.70	122.30	5	161.3	93.6	2
15KPA110A	15KPA110CA	110.0	122.90	134.50	5	178.6	84.5	2
15KPA120A	15KPA120CA	120.0	134.00	146.80	5	192.3	78.5	2
15KPA130A	15KPA130CA	130.0	145.20	159.00	5	208.3	72.5	2
15KPA150A	15KPA150CA	150.0	167.60	183.50	5	241.9	62.4	2
15KPA160A	15KPA160CA	160.0	178.70	195.70	5	258.6	58.4	2
15KPA170A	15KPA170CA	170.0	189.90	207.90	5	272.7	55.4	2
15KPA180A	15KPA180CA	180.0	201.10	220.10	5	288.5	52.3	2
15KPA200A	15KPA200CA	200.0	223.40	244.60	5	319.1	47.3	2
15KPA220A	15KPA220CA	220.0	245.70	269.10	5	349.4	43.2	2
15KPA240A	15KPA240CA	240.0	268.10	293.50	5	384.6	39.3	2
15KPA260A	15KPA260CA	260.0	290.40	318.00	5	416.7	36.2	2
15KPA280A	15KPA280CA	280.0	312.80	342.40	5	454.5	33.2	2

I-V Curve Characteristics

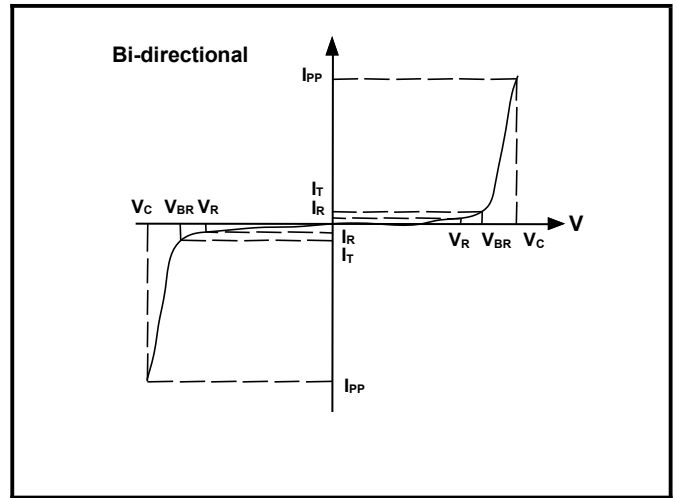
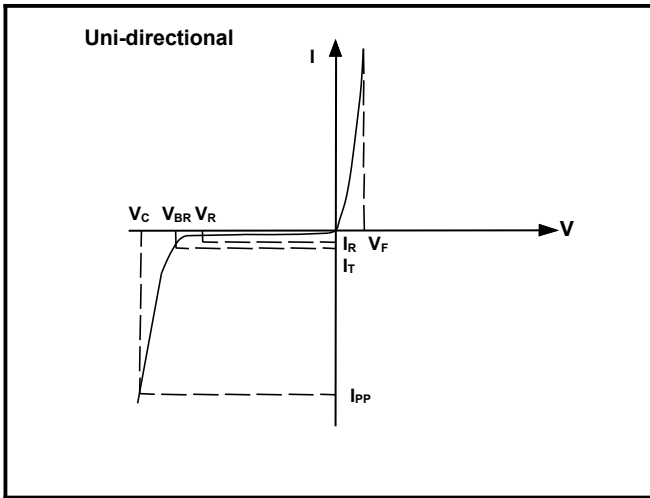

P_{PPM} Peak Pulse Power Dissipation -- Max power dissipation

V_R Stand-off Voltage -- Maximum voltage that can be applied to the TVS without operation

V_{BR} Breakdown Voltage -- Maximum voltage that flows though the TVS at a specified test current (I_T)

V_C Clamping Voltage -- Peak voltage measured across the TVS at a specified I_{ppm} (peak impulse current)

I_R Reverse Leakage Current – Current measured at V_R

V_F Forward Voltage Drop for Uni-directional

Ratings and Characteristic Curves ($T_A=25^\circ C$ unless otherwise noted)

Figure 1 - TVS Transients Clamping Waveform

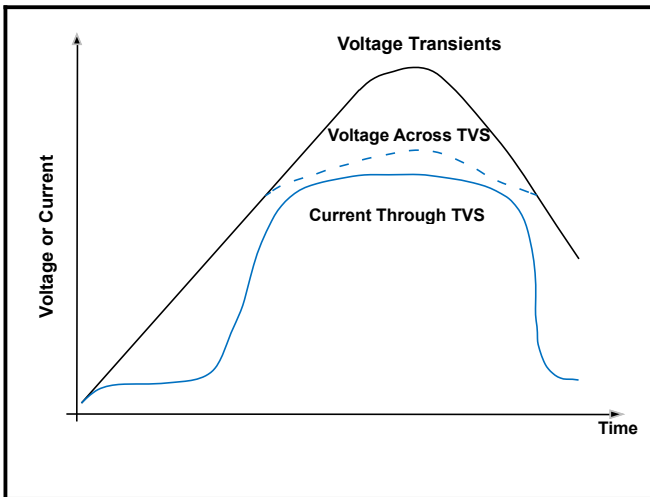

Figure 2 - Peak Pulse Power Rating Curve

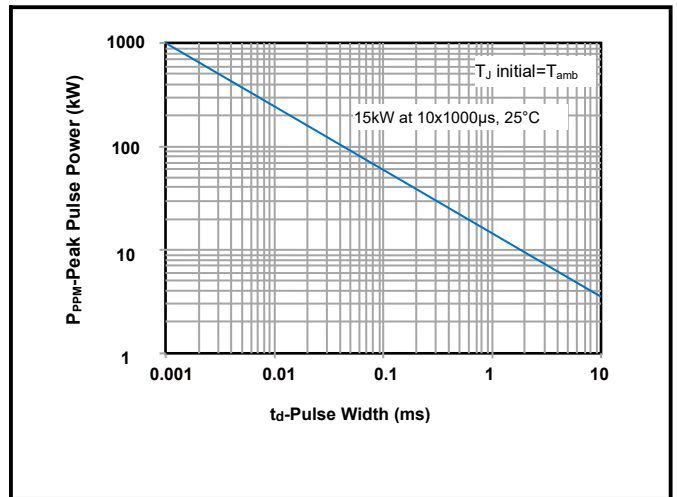

Figure 3 - Pulse Derating Curve

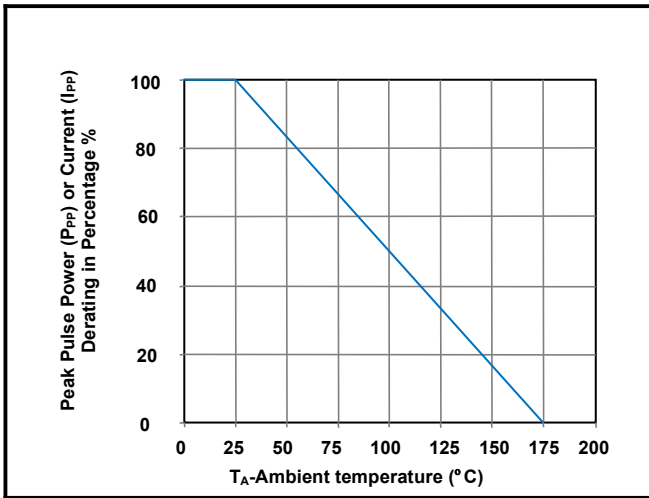

Figure 4 - Pulse Waveform

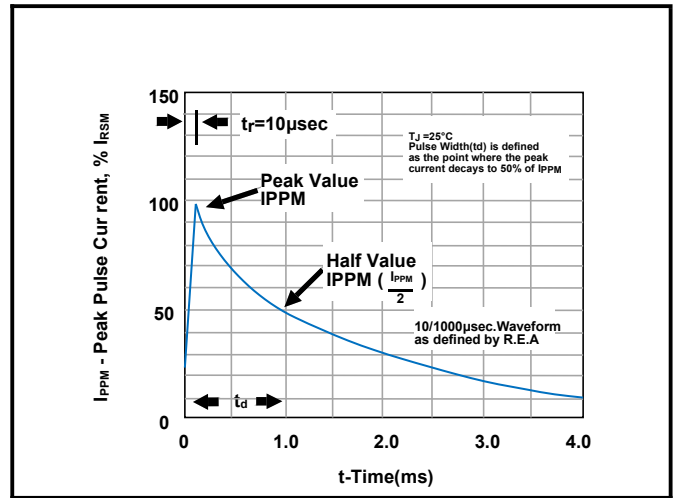

Figure 5 - Typical Junction Capacitance

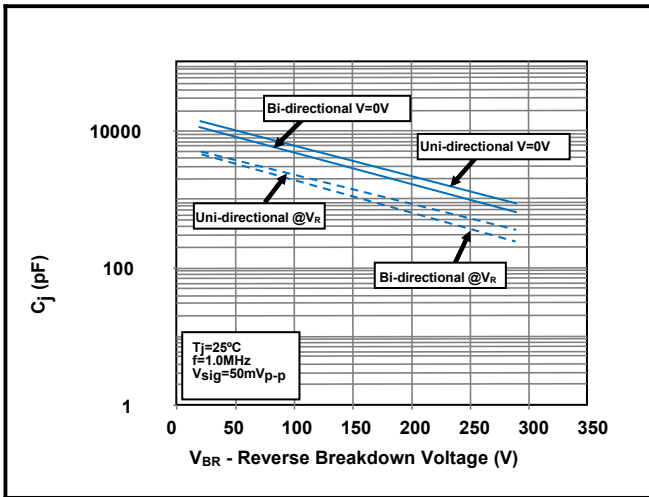

Figure 6 - Steady State Power Derating Curve

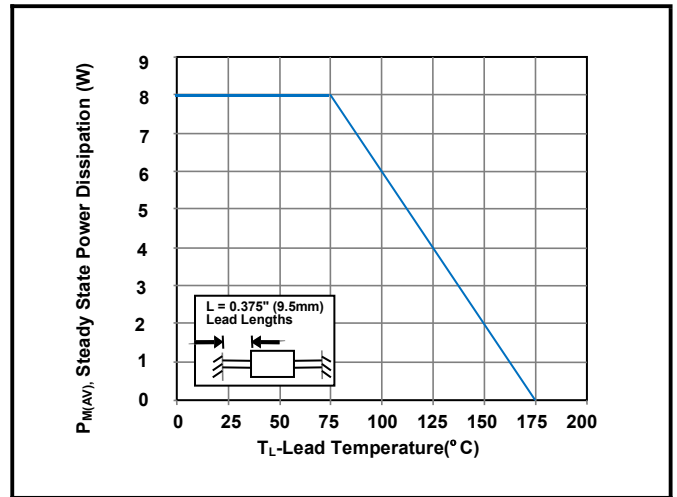
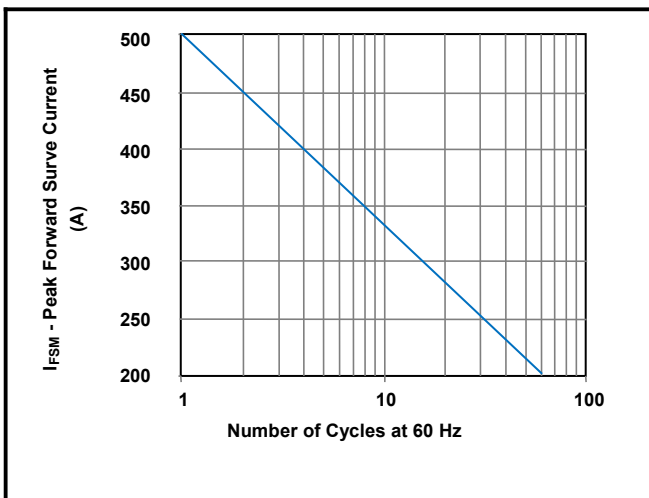
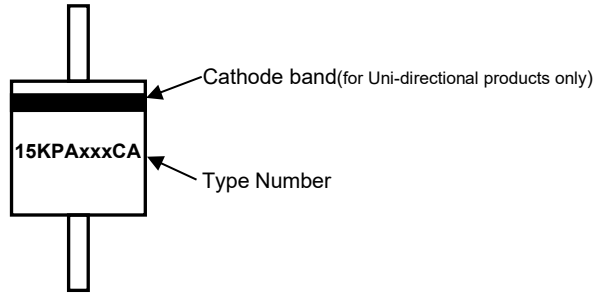

Figure 7 - Maximum Non-Repetitive Surge Current



Part Marking System



Dimensions

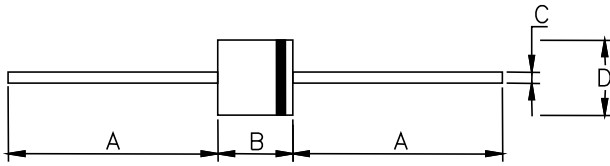

DIM	Millimeters		Inches	
	Min	Max	Min	Max
A	25.4	-	1.000	-
B	8.6	9.14	0.339	0.360
C	1.2	1.32	0.047	0.052
D	8.6	9.14	0.339	0.360

Packaging Information

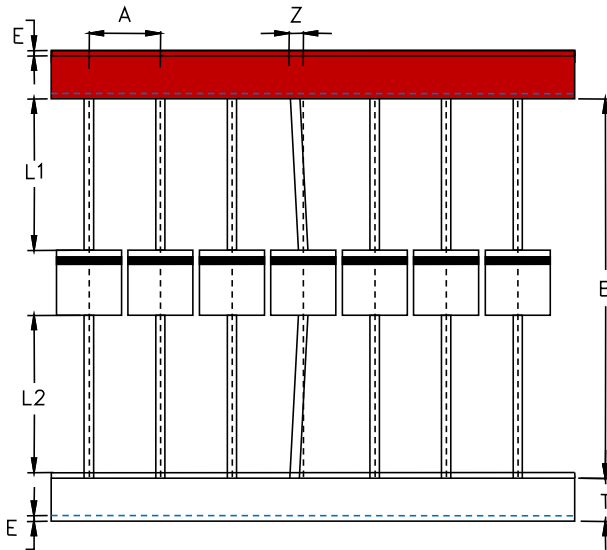

Symbol	Millimeters	Inches
A	10±0.5	0.394±0.019
B	53.0±1.0	2.087±0.039
Z	1.2Max	0.047 Max
T	6.0±0.5	0.236±0.019
E	0.8Max	0.031 Max
L1-L2	1.0Max	0.039 Max

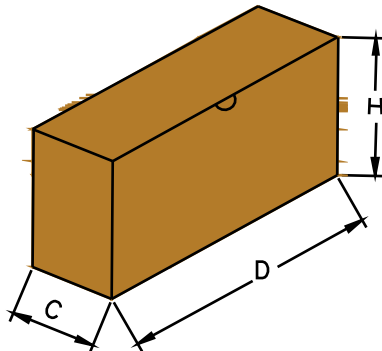

Symbol	Millimeters	Inches
D	250.0±5.0	9.843±0.197
C	75.0±5.0	2.953±0.197
H	114.0±5.0	4.488±0.197
Quantity	300PCS/ inner box	